









SISTEMA / CORREDERO LATERAL

SISTEMA	Hojas correderas laterales, suspendida en guía superior de aluminio y con guíadores o guía inferior.
MATERIAL	Aluminio extrusionado con aleación 6063-T5
ACABADOS	Gama RAL estándar Durmi: RAL1015, 5008, 5010, 6005, 6009, 6028, 7011, 7012, 7016, 7022, 7031, 7035, 8014, 8017, 8019, 9005, 9011, 9010, 9016, Anodizado natural plata Cualquier RAL de la gama existente en el mercado disponible como opción.
CARACTERÍSTICAS	Sistema de apertura lateral con accionamiento manual (opcional eléctrico). Apertura 100%. Cierre interior de hojas. Bloqueo en dos puntos (superior e inferior) Resistencia al viento hasta Clase 6. Posibilidad de instalar lamas Durmi o Dupanel, con un peso máximo de 10 kg/m ² cada hoja. Posibilidad de motorizar sistema bajo consulta. Consultar posibilidad de instalar paneles especiales.
CERTIFICADOS	        



OPCIONES DE DISEÑO / CORREDERO LATERAL

- Sistema de hasta 4 hojas por hueco (otras cantidades consultar).
- Sistema de guía simple o guía doble.
- Posibilidad de fijación de guía superior a frontal de pared o debajo de techo.
- Sistemas de guiado inferior:
 - Guía inferior invertida incorporada a la hoja (guiadores a suelo / guiadores ventana o vierteaguas – guiadores a pared)
 - Guía inferior vista.
 - Guía inferior empotrada.

1 hoja guía simple

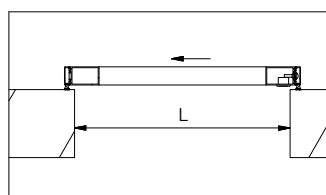
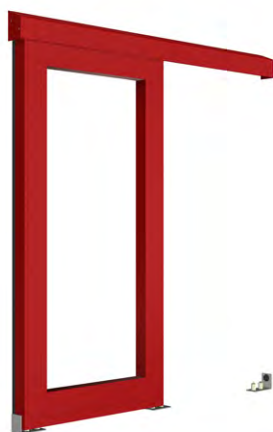

2 hojas guía simple

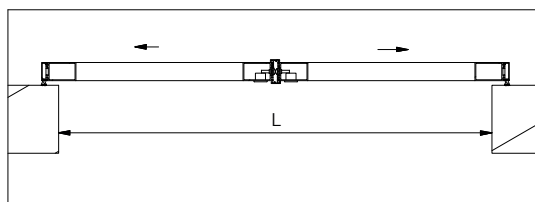
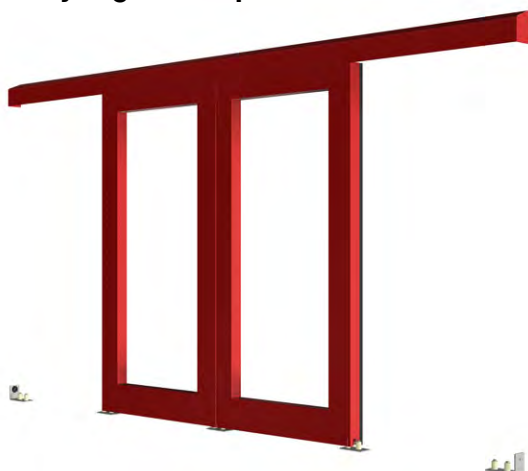



2 hojas guía doble

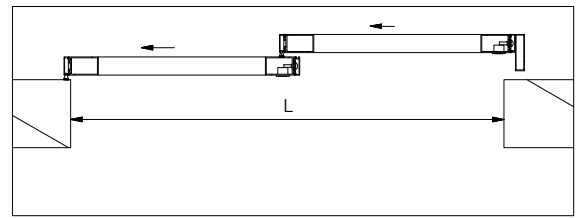

3 hojas guía doble

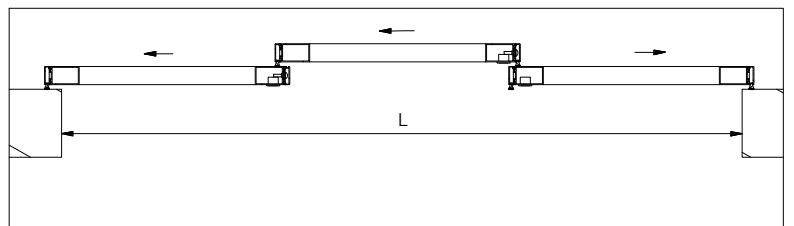



4 hojas guía doble

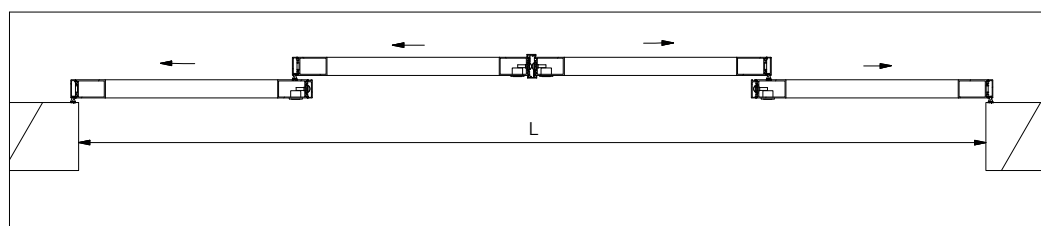
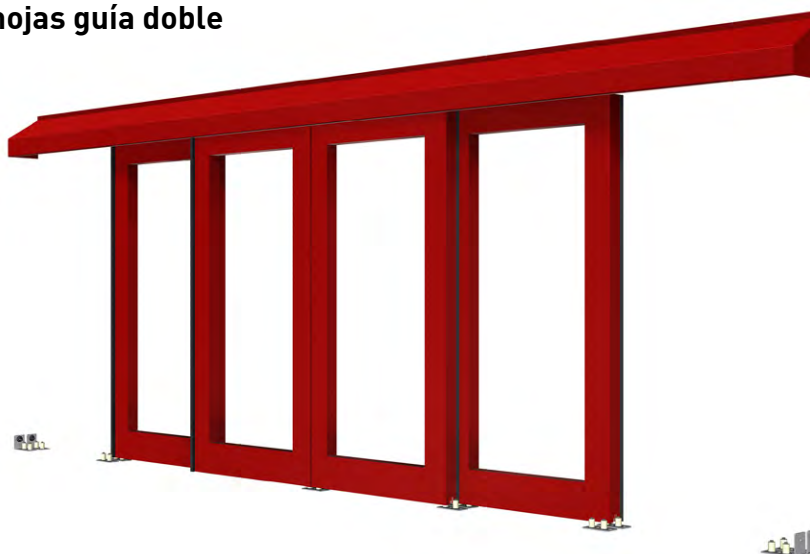

BASTIDORES / CORREDERO LATERAL

RANURADOS



40 x 45 mm



40 x 66 mm

Dutec s, Dutec r, Dutec e (hasta 210e),
Dutec t (hasta 200t), **Dupanel**.

BASTIDOR U



40 x 45 U mm



40 x 63 U mm

Dufix m, Dufix t.



GUÍAS EN SECCIÓN / CORREDERO LATERAL

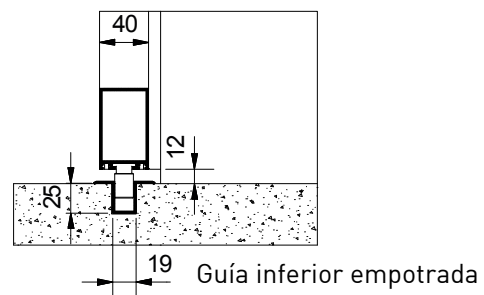
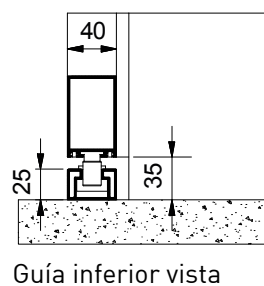
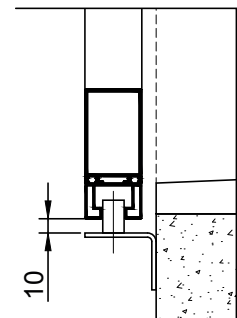
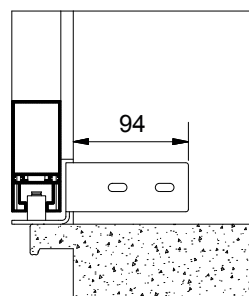
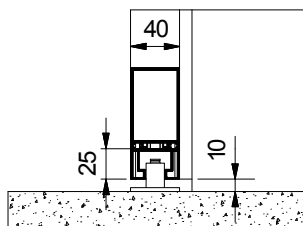
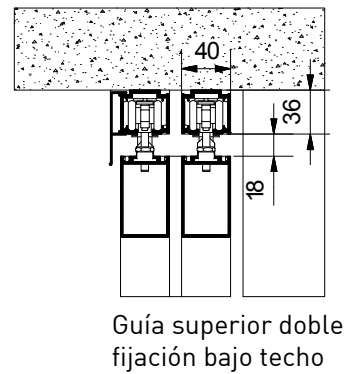
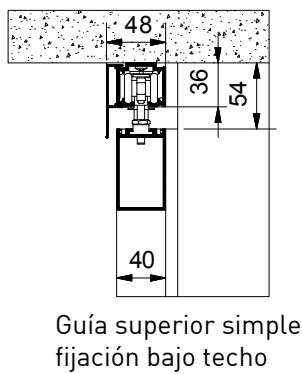
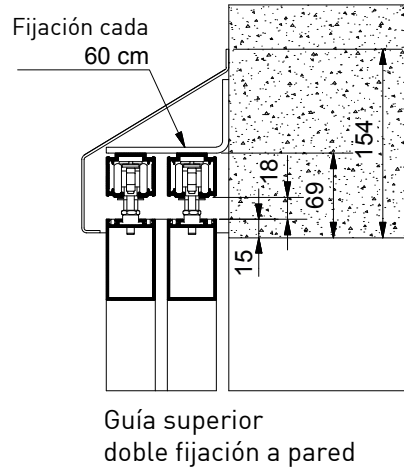
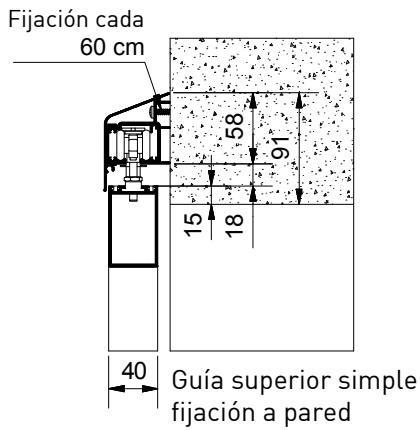



Sistema
Corredero lateral

TIPOS DE CIERRE / CORREDERO LATERAL



Cremona



Maneta doble o una cara.
Con o sin llave



Pasador normal
(hojas pasivas)



Pasador con llave

Fábrica. oficinas y show-room:

C. Bages, S/N · P.L. Vilanoveta
08812 Sant Pere de Ribes · Barcelona
T. +34 938 932 808 F. +34 938 933 560
durmi@durmi.com · www.durmi.com

Podéis seguirnos en:



Representación Nacional

MADRID ZONA CENTRO · PAÍS VASCO ZONA NORTE
ANDALUCÍA ZONA SUR · ARAGÓN · LEVANTE
BALEARES · CANARIAS

Representación Exportación

PORTUGAL · FRANCE · BELGIUM · NETHERLANDS
SWITZERLAND · ANDORRA · REPÚBLICA DOMINICANA
CUBA · CHILE